

1 Plan
1 : 15

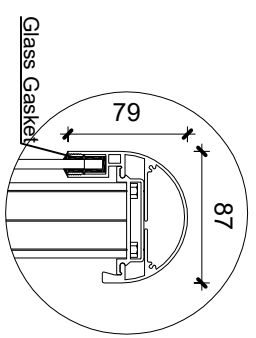

4 Detail 1
1 : 5

1100.00 mm

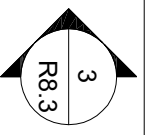
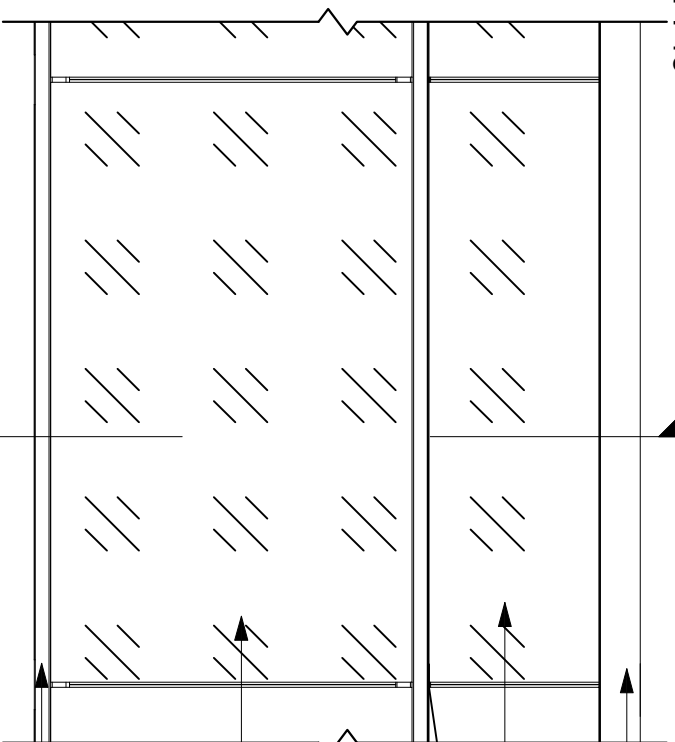

2 Front view
1 : 15

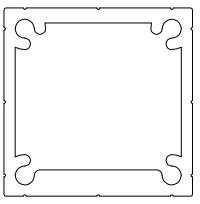

7 LRP001
1 : 2

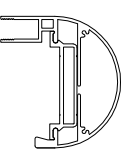

8 LRT 101
1 : 5

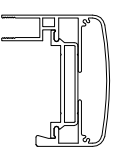

9 LRT102
1 : 5

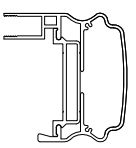

10 LRT 103
1 : 5

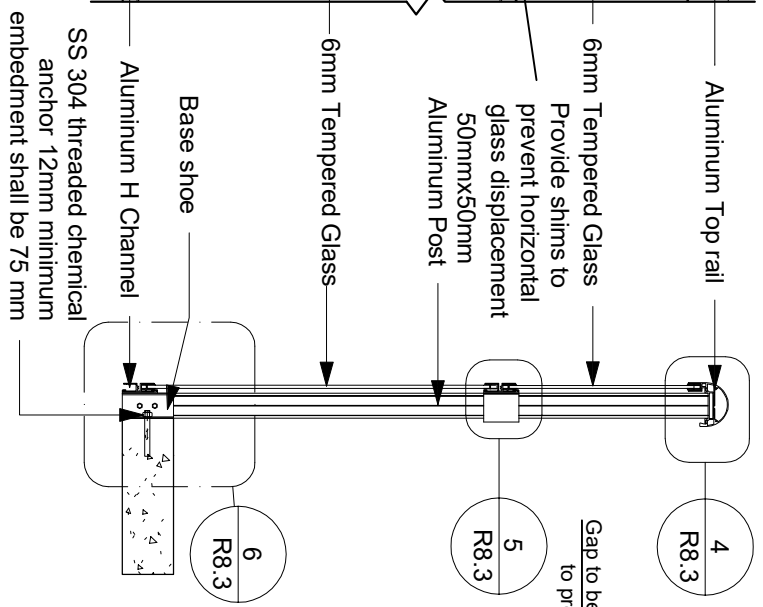

3 Cross section
1 : 15

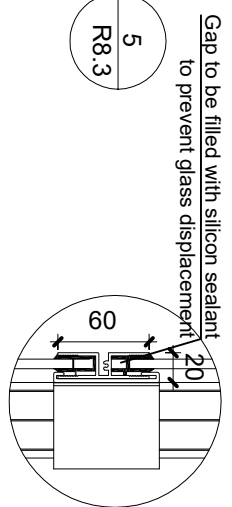

5 Detail 2
1 : 5

Gap to be filled with silicon sealant to prevent glass displacement

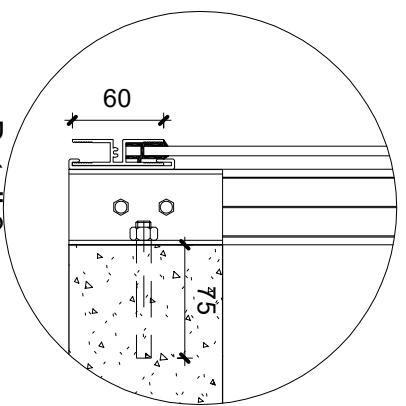

6 Detail 3
1 : 5

General Notes

No.	Revision/Issue	Date

Link
RAILINGS
LINK ALUMINUM RAILING
589, MIDDLERFIELD ROAD,
SCARBOROUGH, ON
linkaluminumrailing@gmail.com

LRGP-0002 Side Mounted
Clear Double Glass Panel
Combined

Project	Sheet
Date 22-04-2022	R8.3
Scale N.T.S.	