

1 Plan  
1 : 15

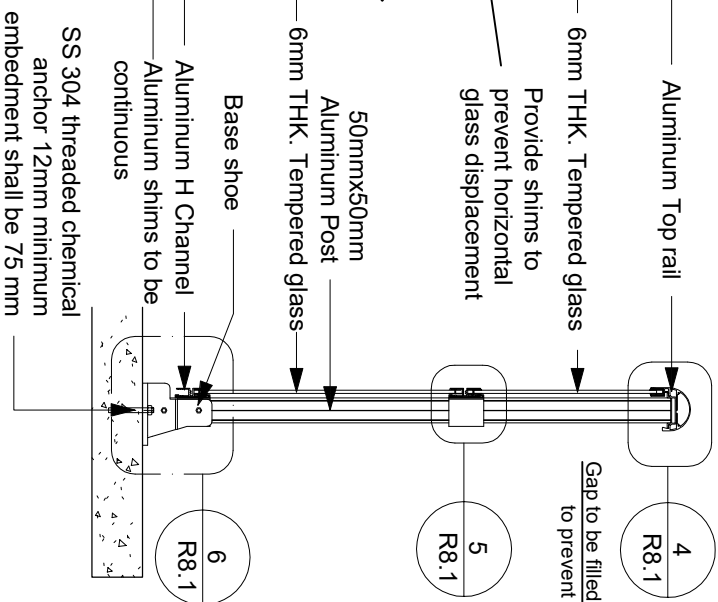

2 Front view  
1 : 15

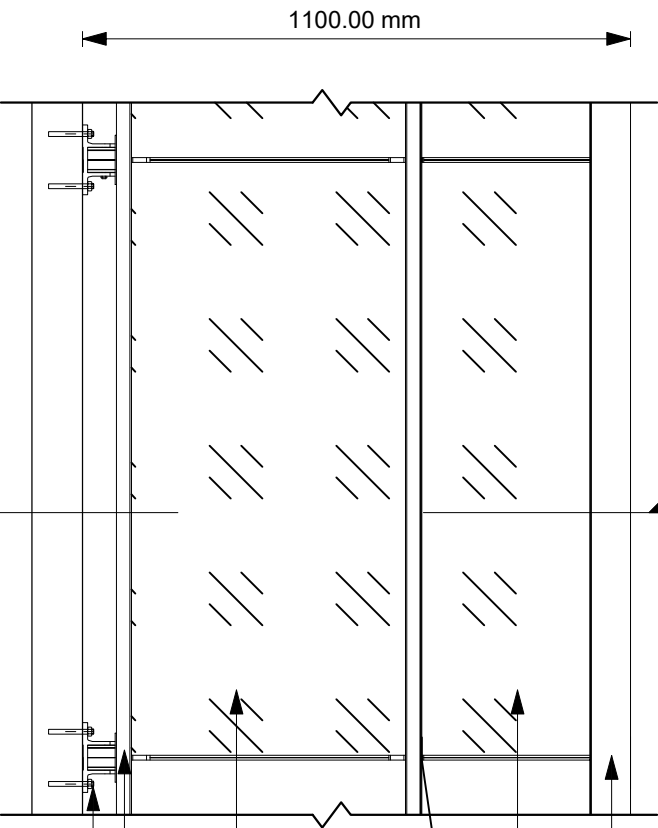
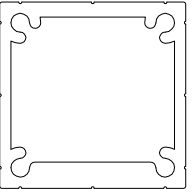

3 Cross section  
1 : 15

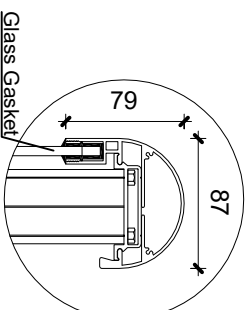
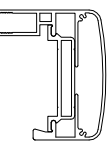

4 Detail 1  
1 : 5

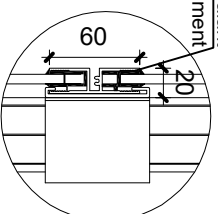

5 Detail 2  
1 : 5

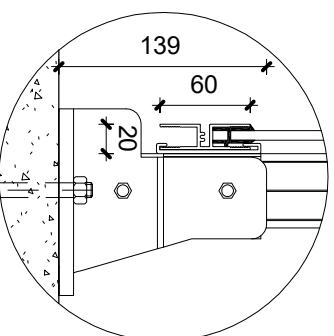

6 Detail 3  
1 : 5

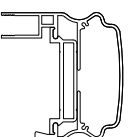

7 LRP001  
1 : 2

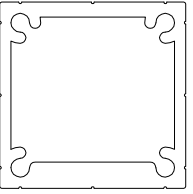

8 LRT 101  
1 : 5

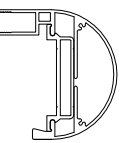

9 LRT102  
1 : 5

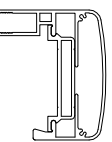

10 LRT 103  
1 : 5

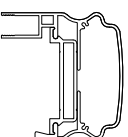

General Notes

No.	Revision/Issue	Date

**Link**  
RAILINGS  
LINK ALUMINUM RAILING  
589, MIDDLEFIELD ROAD,  
SCARBOROUGH, ON  
linkaluminumrailing@gmail.com

LRDG-0001 Top Mounted  
Clear Double Glass Panel  
Combined

Project	Sheet
Date	R8.1
Scale	N.T.S.