

1 Plan
1 : 15

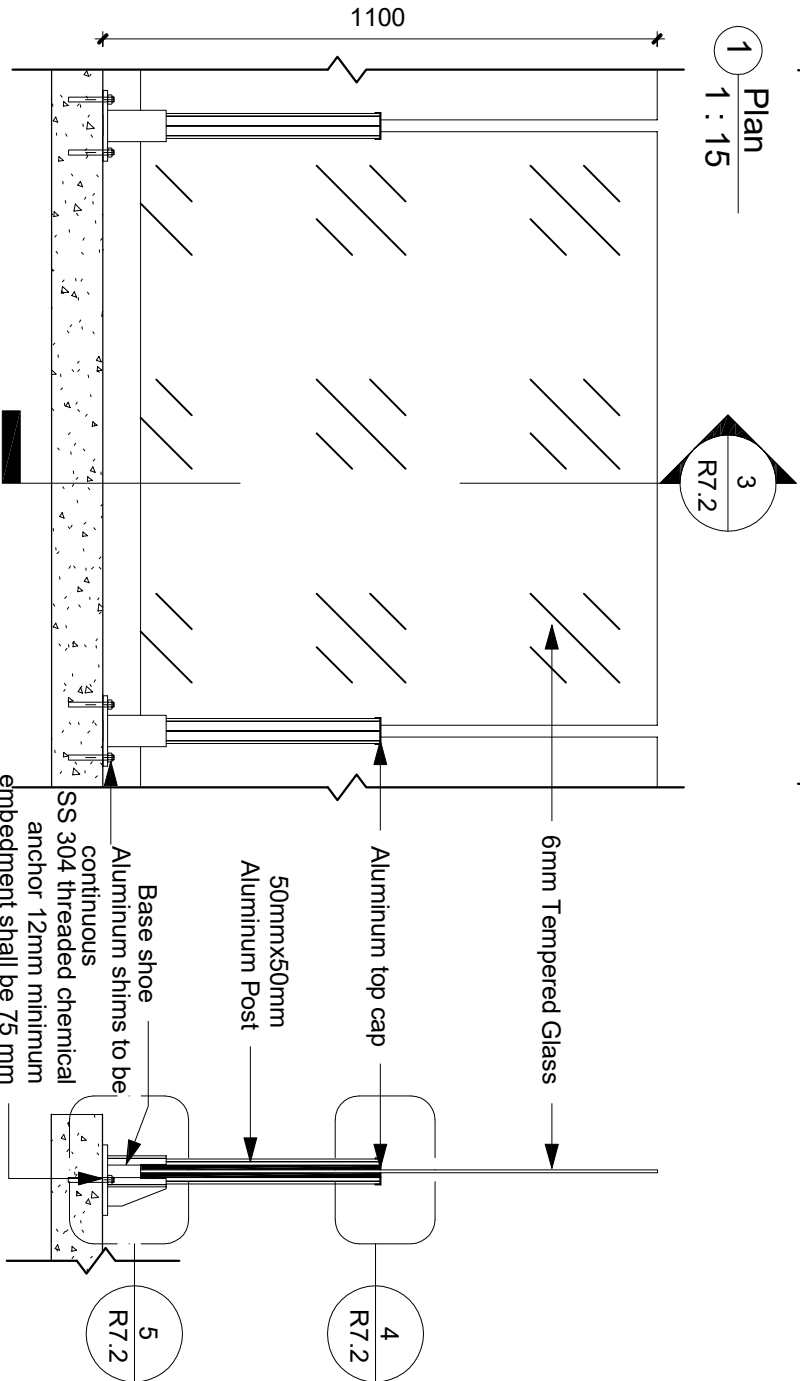

2 Front view
1 : 15

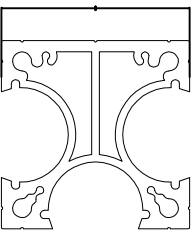

6 Post
1 : 2

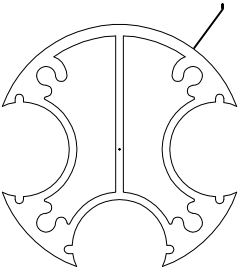

7 Round Post
1 : 2

3 Cross section
1 : 15

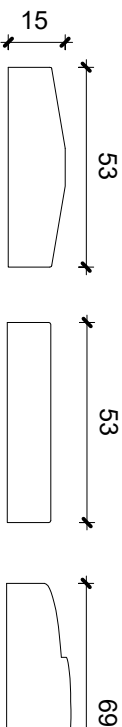

8 Top cap 1
1 : 2

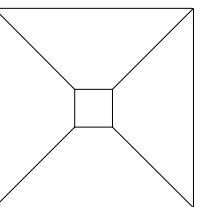

9 Top cap 2
1 : 2

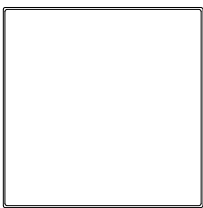

10 Top cap 3
1 : 2

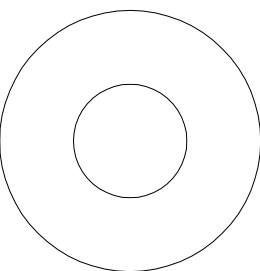

11 Top cap 4
1 : 2

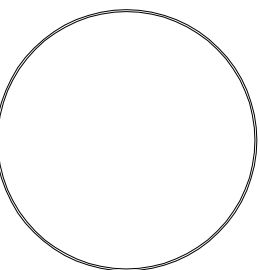

4 Detail 1
1 : 5

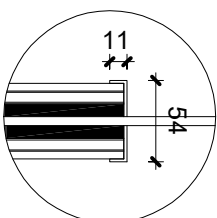

5 Detail 2
1 : 5

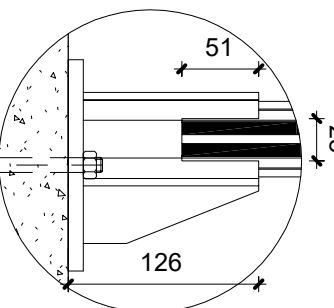

General Notes

No.	Revision/Issue	Date

Link
RAILINGS

LINK ALUMINIUM RAILING
589, MIDDI, EFIELD ROAD,
SCARBOROUGH, CN
linkaluminiumrailings@gmail.com

LRT-0001 Top Mounted Full post Thornridge system

Project	Sheet
Date 22-04-2022	R7.2
Scale N.T.S.	