

1 Plan
1 : 15

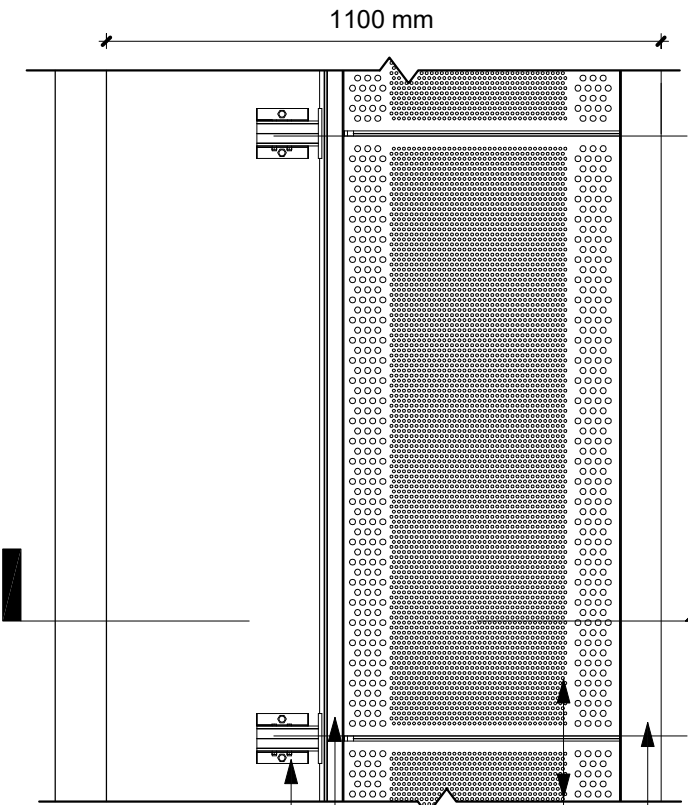

2 Front elevation
1 : 15

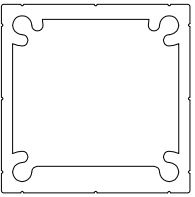

6 LRP001
1 : 2

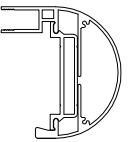

7 LRT101
1 : 5

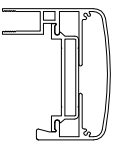

8 LRT102
1 : 5

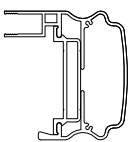

9 LRT103
1 : 5

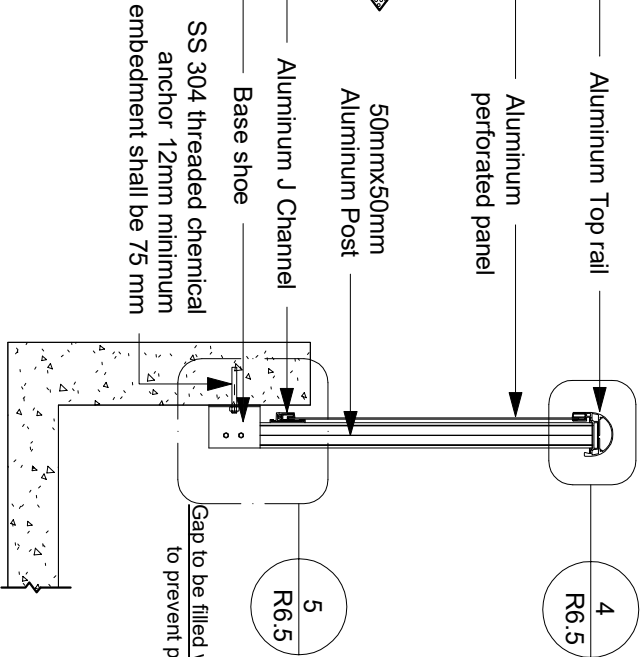

3 Cross section
1 : 15

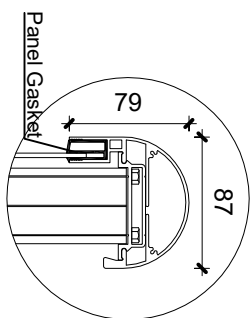

4 Detail 1
1 : 5

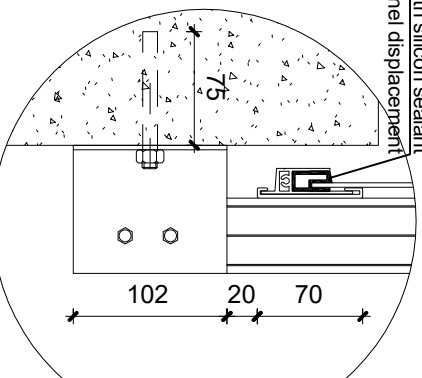

5 Detail 2
1 : 5

General Notes

No.	Revision/Issue	Date

Link
RAILINGS
LINK ALUMINIUM RAILING
589 MIDDI EFIELD ROAD,
SCARBOROUGH, ON
linkaluminiumrailings@gmail.com

LRPP-0004 Wall Mounted
Parapet Perforated panel
system

Project	Sheet
Date 22-04-2022	R6.5
Scale N.T.S.	