

1 Plan
1 : 15

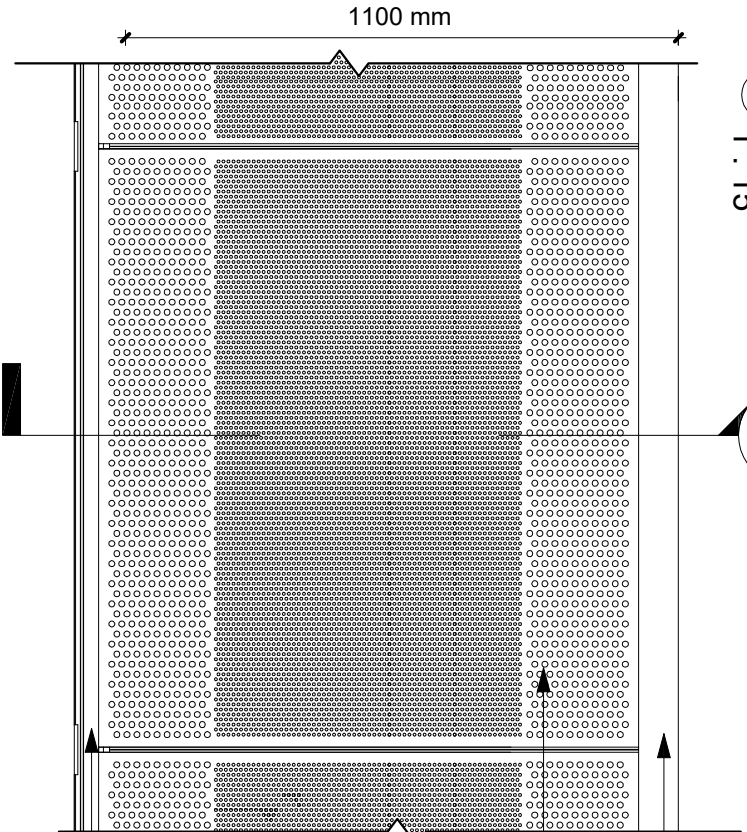

5 Front view
1 : 15

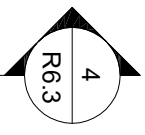
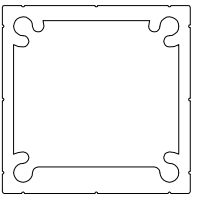

9 LRP001
1 : 2

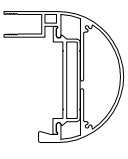

6 LRT101
1 : 5

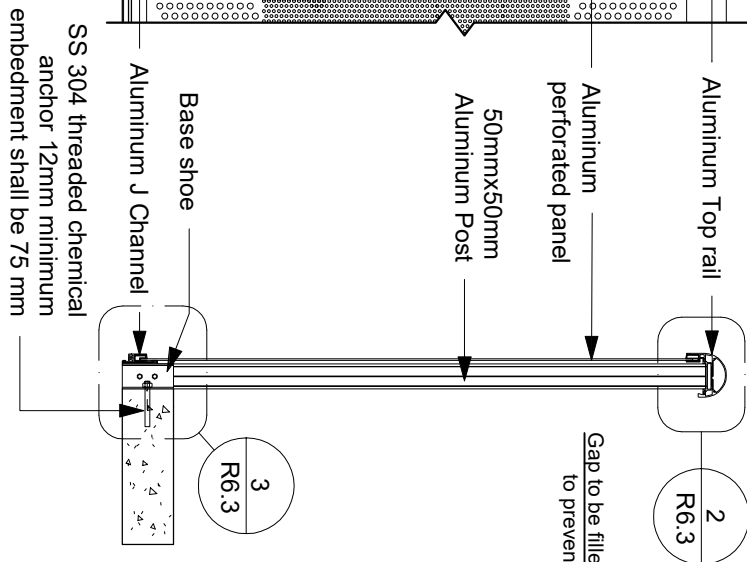

4 Cross section
1 : 15

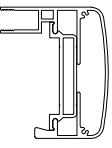

7 LRT102
1 : 5

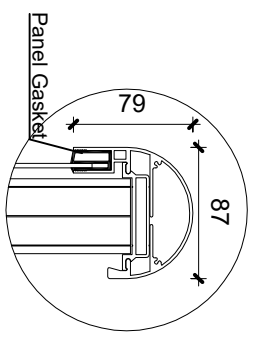

Panel Gasket

2 Detail 1
1 : 5

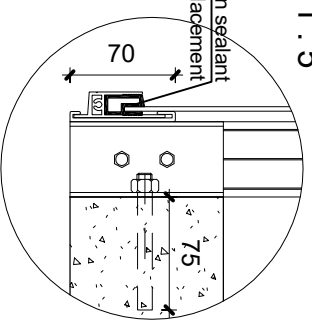

3 Detail 2
1 : 5

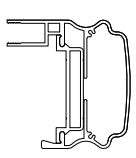

8 LRT103
1 : 5

General Notes

No.	Revision/Issue	Date

Link
RAILINGS
LINK ALUMINUM RAILING
689 MIDDLERFIELD ROAD,
SCARBOROUGH, ON
linkaluminiumrailings@gmail.com

LRPP-0002 Side Mounted
Perforated panel system

Project	Sheet
Date	R6.3
22-04-2022	
Scale	
N.T.S.	