

1 Plan  
1 : 15

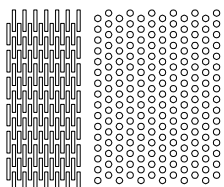

11 Panel options  
1 : 7

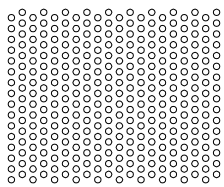
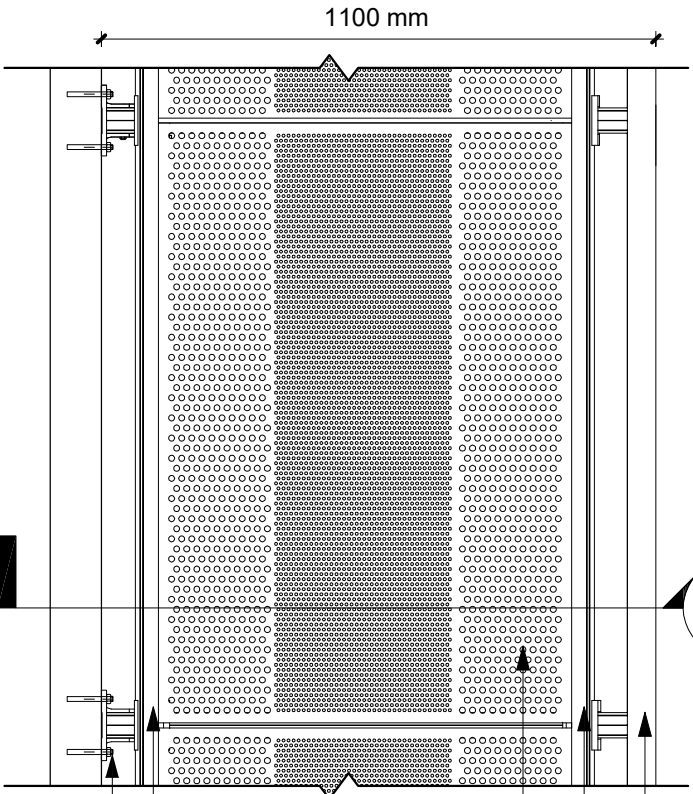
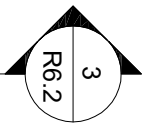
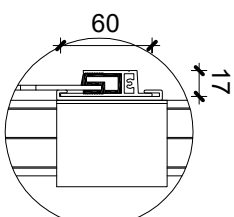

4 Detail 1  
1 : 5

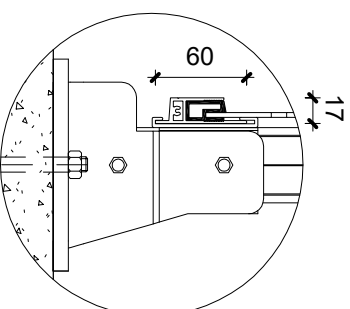

5 Detail 2  
1 : 5

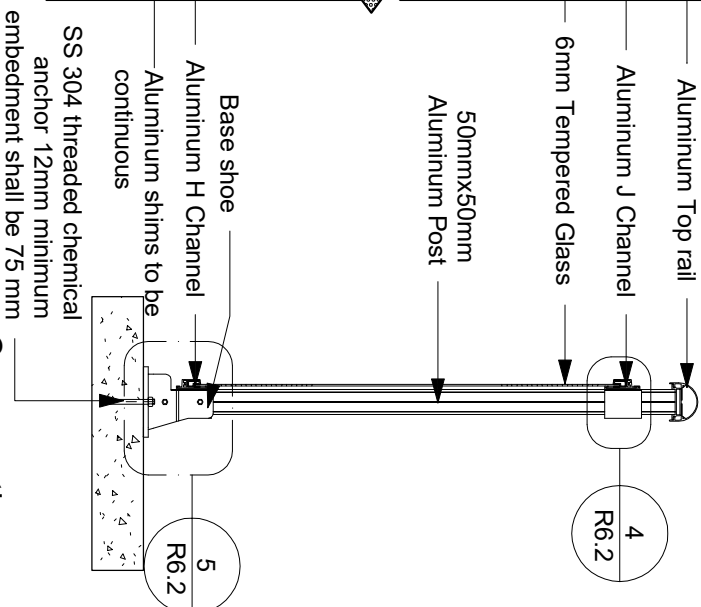

3 Cross section  
1 : 15

2 Front Elevation  
1 : 15

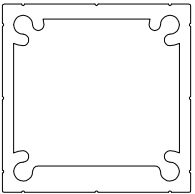

6 LRP001  
1 : 2

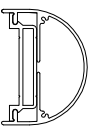

7 LRT001  
1 : 5

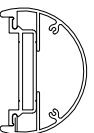

8 LRT002  
1 : 5

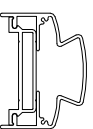

9 LRT003  
1 : 5

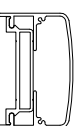

10 LRT004  
1 : 5

General Notes

No.	Revision/Issue	Date

**Link**  
RAILINGS  
LINK ALUMINIUM RAILING  
589, MIDDI EFIELD ROAD,  
SCARBOROUGH, ON  
linkaluminiumrailings@gmail.com

LRPP-0001-A Top Mounted  
Perforated panel system

Project	Sheet
Date 22-04-2022	R6.2
Scale N.T.S.	