

1 Plan
1 : 15

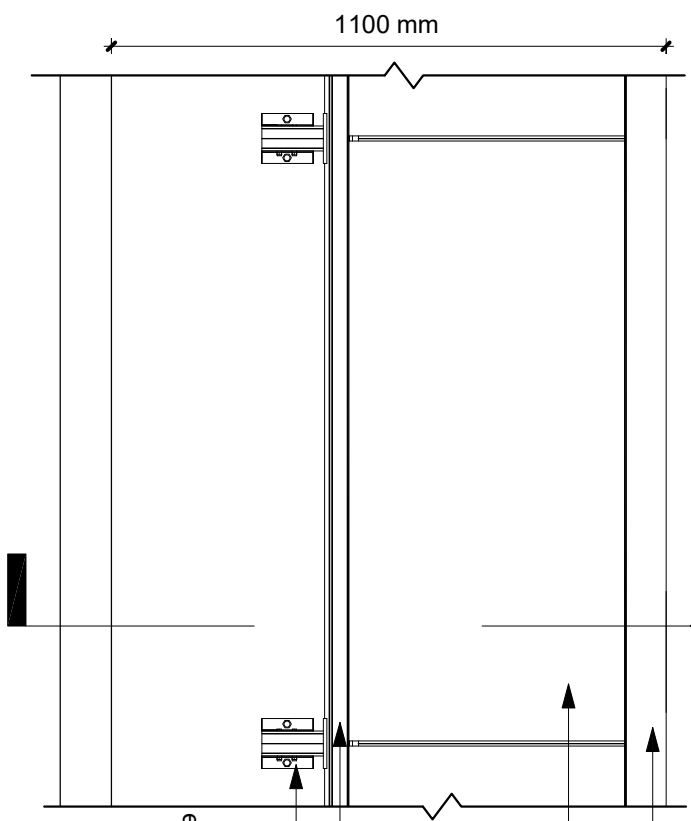

3
R5.5

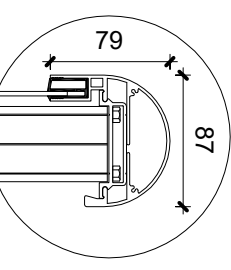

4
1 : 5

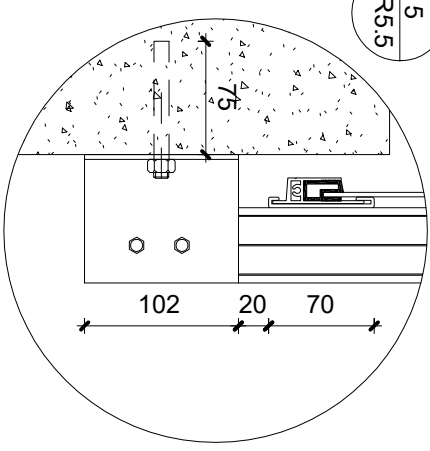

5
1 : 5

Aluminum Top rail
Aluminum panel
50mmx50mm Aluminum Post
Aluminum J Channel
Base shoe
SS 304 threaded chemical anchor 12mm minimum embedment shall be 75 mm

2 Front elevation
1 : 15

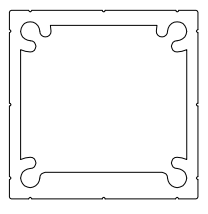

3 Cross section
1 : 15

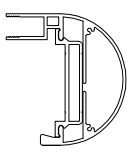

8 LRT102
1 : 5

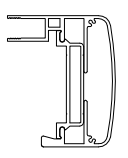

9 LRT103
1 : 5

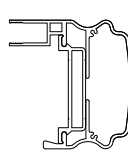

6 LRP001
1 : 2

7 LRT101
1 : 5

8 LRT102
1 : 5

9 LRT103
1 : 5

No.	Revision/Issue	Date

Link
RAILINGS
LINK ALUMINUM RAILING
589 MIDDL EFIELD ROAD,
SCARBOROUGH ON
linkaluminumrailings@gmail.com

LRP-0004 Side Mounted Parapet Aluminum panel system

Project	Sheet
Date 22-04-2022	R5.5
Scale N.T.S.	