

1 Plan  
1 : 15

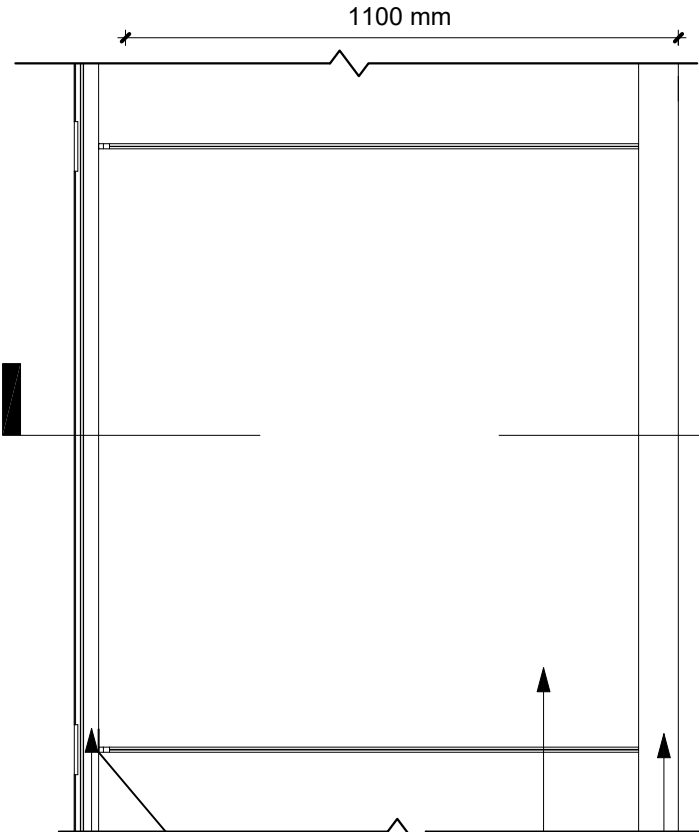

5 Front view  
1 : 15

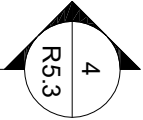
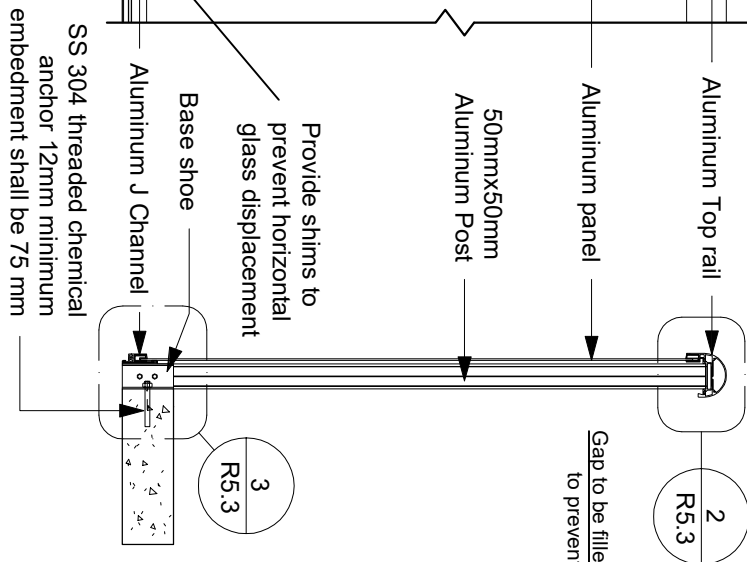
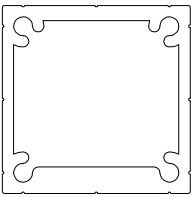

4 Cross section  
1 : 15

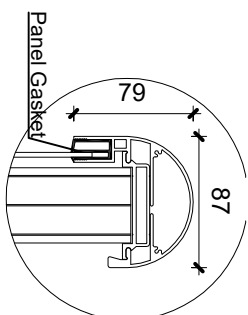
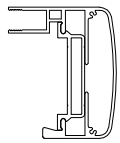

Panel Gasket

2 Detail 1  
1 : 5

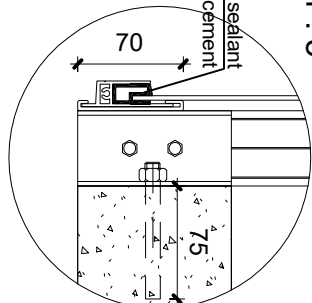

3 Detail 2  
1 : 5

9 LRP001  
1 : 2

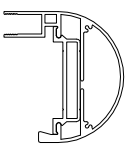

6 LRT101  
1 : 5

7 LRT102  
1 : 5

8 LRT103  
1 : 5

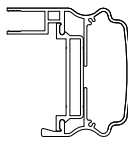

General Notes

No.	Revision/Issue	Date

**Link**  
RAILINGS  
LINK ALUMINUM RAILING  
589 MIDFIELD ROAD,  
SCARBOROUGH, ON  
linkaluminumrailings@gmail.com

LRP-0002 Side Mounted  
Aluminum panel system

Project	Sheet
Date	R5.3
22-04-2022	
Scale	N.T.S.