

Aluminum base plate

1 Plan
1 : 15

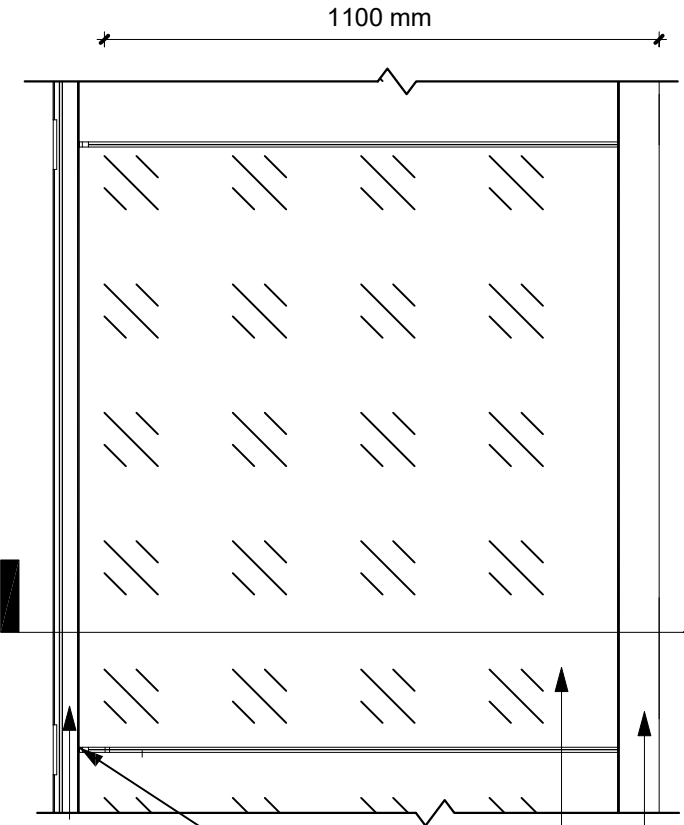

2 Front elevation
1 : 15

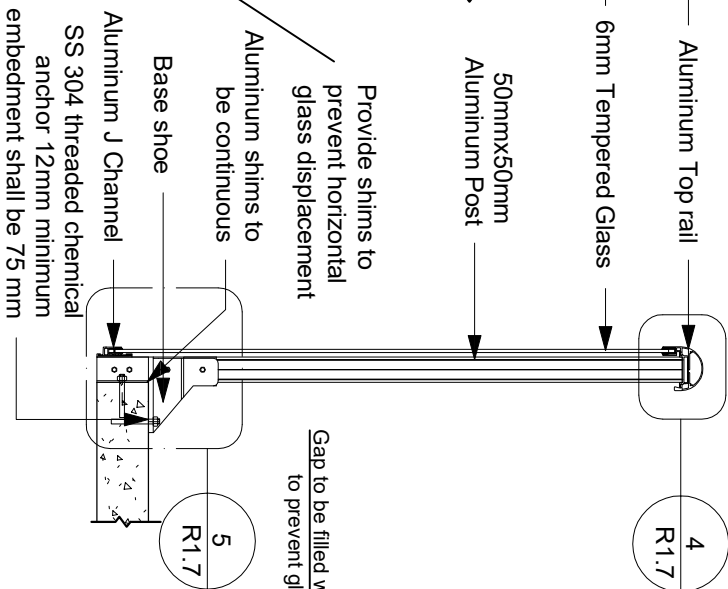
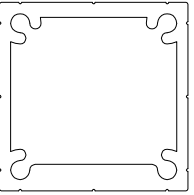

3 Cross section
1 : 15

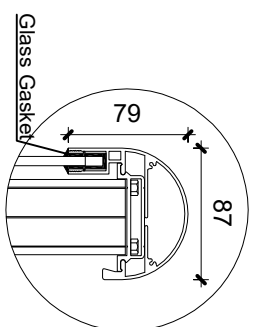
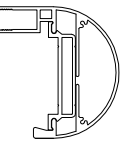

4 Detail 1
1 : 5

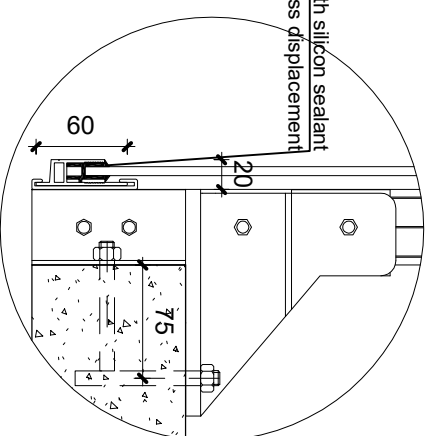

5 Detail 2
1 : 5

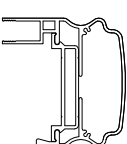
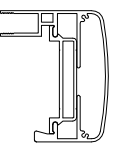

6 LRP001
1 : 2

7 LRT101
1 : 5

8 LRT102
1 : 5

9 LRT103
1 : 5

General Notes

No.	Revision/Issue	Date

Link
RAILINGS
LINK ALUMINUM RAILING
589 MIDDLERFIELD ROAD,
SCARBOROUGH, ON
linkaluminumrailings@gmail.com

LRG-0003 Overhung Top
Mounted Glass System

Project	Sheet
Date 22-04-2022	R1.7
Scale N.T.S.	