

1 Plan  
1 : 15

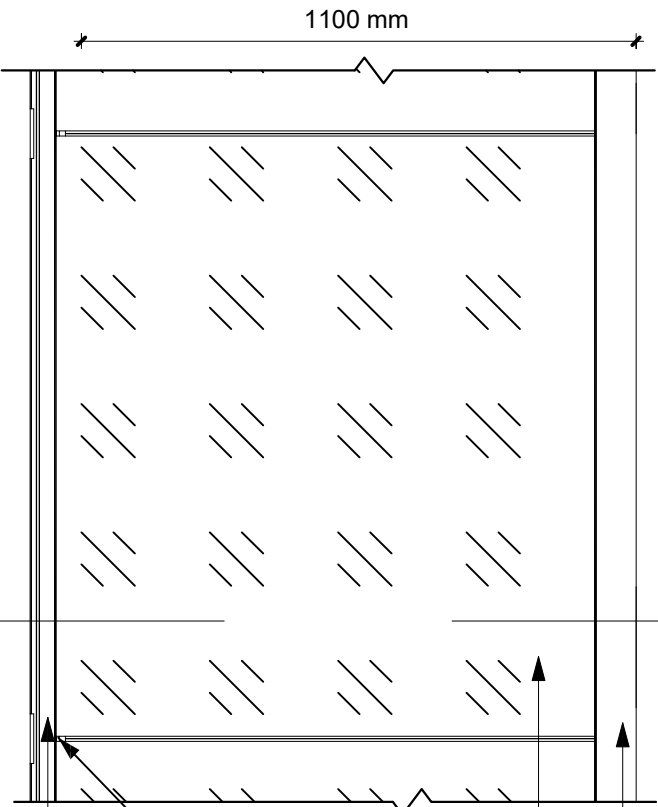

2 Front elevation  
1 : 15

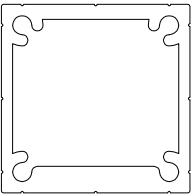

6 LRP001  
1 : 2

3 Cross section  
1 : 15

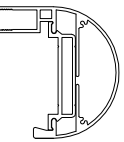

7 LRT101  
1 : 5

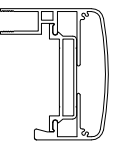

8 LRT102  
1 : 5

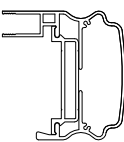

9 LRT103  
1 : 5

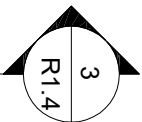

Aluminum Top rail  
6mm Tempered Glass  
50mmx50mm Aluminum Post  
Aluminum J Channel  
Base shoe  
Provide shims to prevent horizontal glass displacement  
SS 304 threaded chemical anchor 12mm minimum embedment shall be 75 mm

4 R1.4

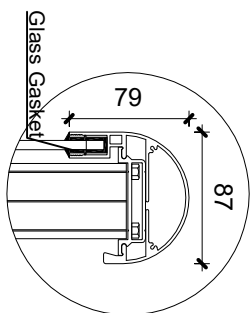

4 Detail 1  
1 : 5

5 R1.4

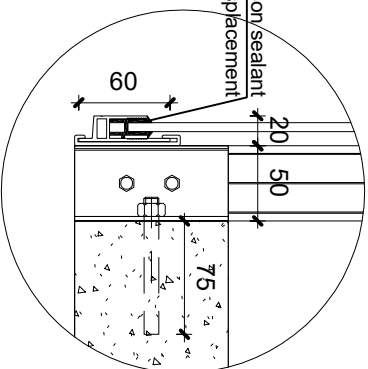

5 Detail 2  
1 : 5

General Notes

**Link**  
RAILINGS  
LINK ALUMINUM RAILING  
589 MIDDLERFIELD ROAD,  
SCARBOROUGH, ON  
linkaluminumrailings@gmail.com

LRG-0002 Side Mounted  
Clear Glass Panels

|                 |       |
|-----------------|-------|
| Project         | Sheet |
| Date 22-04-2022 | R1.4  |
| Scale N.T.S.    |       |

| No. | Revision/Issue | Date |
|-----|----------------|------|
|     |                |      |