

Base shoe

1 Plan
1:15

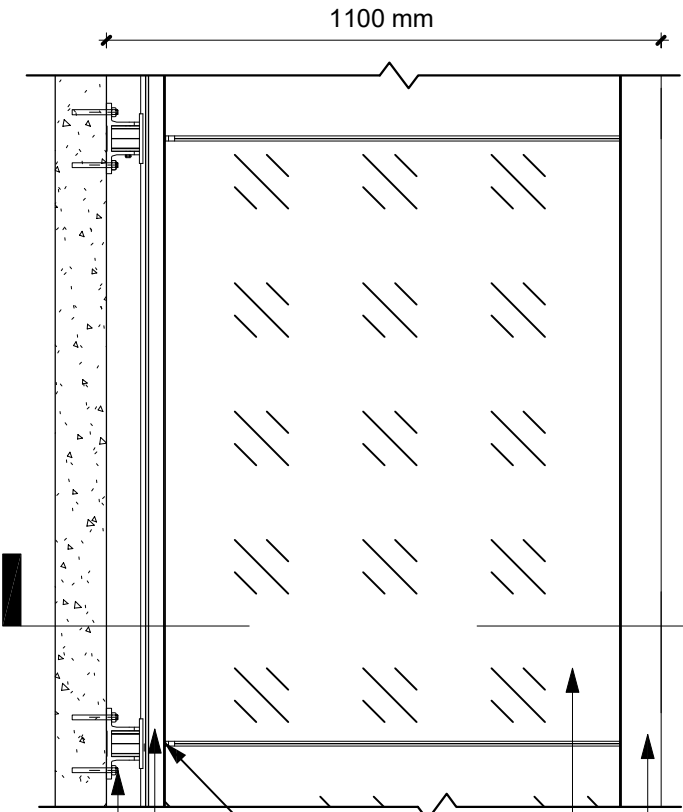

1100 mm

3
R1.1

2 Front elevation
1:15

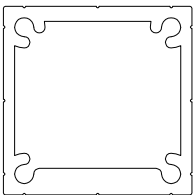

6 LRP001
1:2

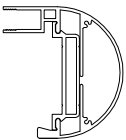

7 LRT101
1:5

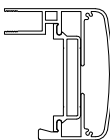

8 LRT102
1:5

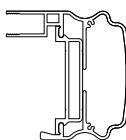

9 LRT103
1:5

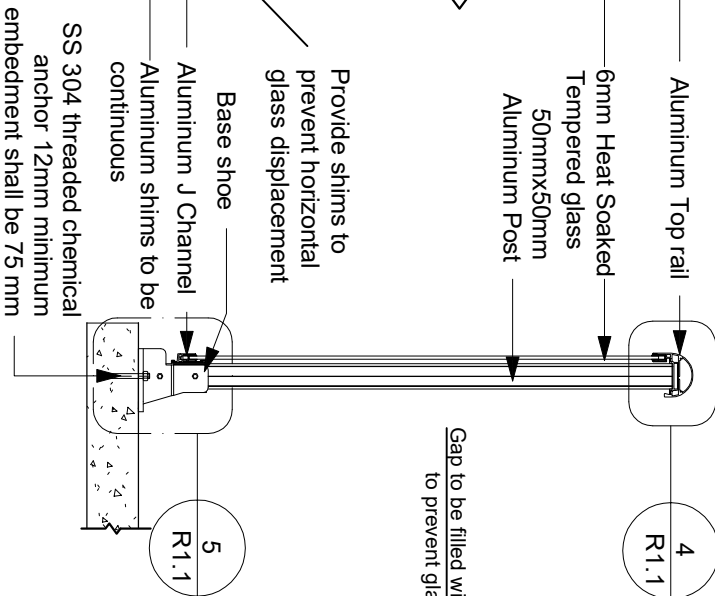

3 Cross section
1:15

5 Detail 2
1:5

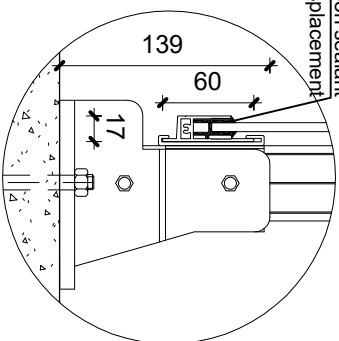

4 Detail 1
1:5

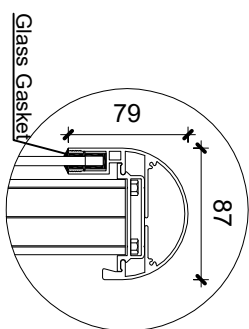

Gap to be filled with silicon sealant to prevent glass displacement

General Notes

Link
RAILINGS

LINK ALUMINUM RAILING
589 MIDDLERFIELD ROAD,
SCARBOROUGH, ON
linkaluminumrailings@gmail.com

LRG-0001 Top Mounted Glass Panels

Project	Sheet
Date 22-04-2022	R1.1
Scale N.T.S.	

No.	Revision/Issue	Date