

1 Plan
1 : 20

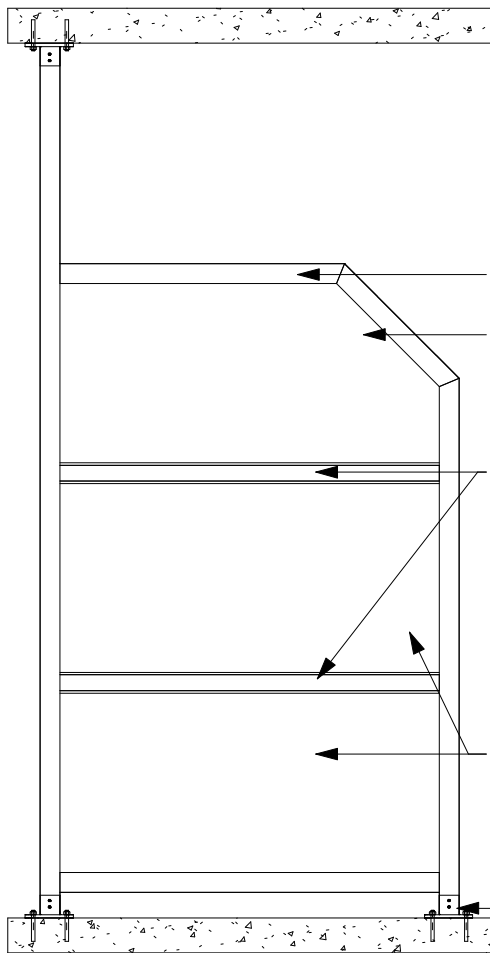

2 Front Elevation
1 : 20

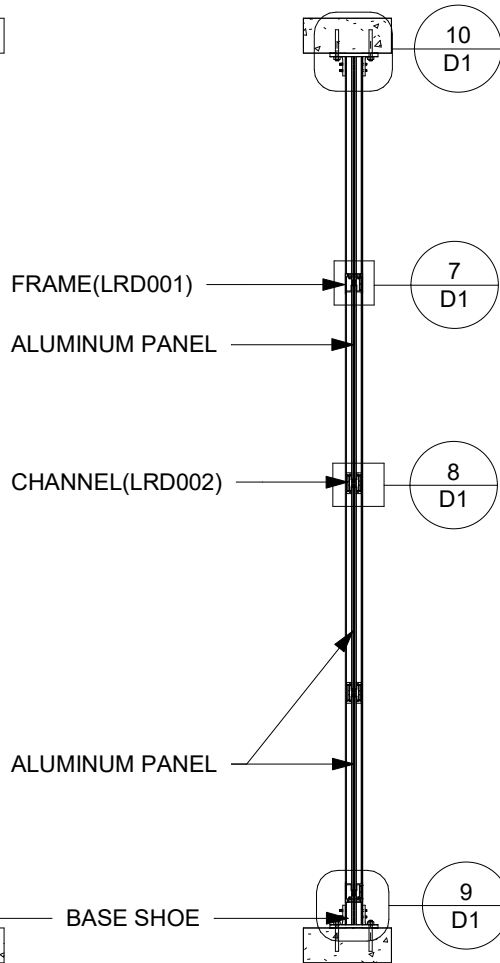

3 Cross section
1 : 20

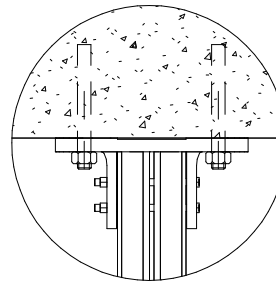

10 Detail 4
1 : 5

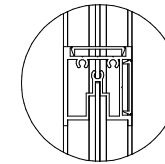

7 Detail 1
1 : 5

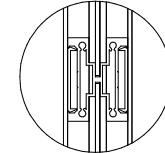

8 Detail 2
1 : 5

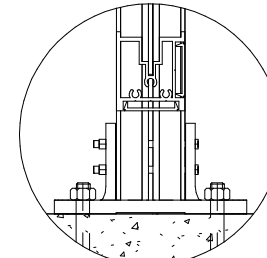

9 Detail 3
1 : 5

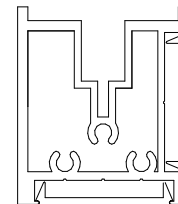

5 LRD001
1 : 2

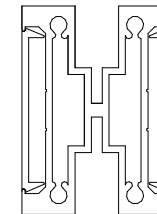

6 LRD002
1 : 2

General Notes

No.	Revision/Issue	Date



LINK ALUMINUM RAILING
589, MIDDLEFIELD ROAD,
SCARBOROUGH, ON
linkaluminumrailing@gmail.com

LRD-001-B Metal panel
divider system

Project	Sheet
Date 22-04-2022	D5
Scale N.T.S.	