

Base shoe

1 Plan
1 : 15

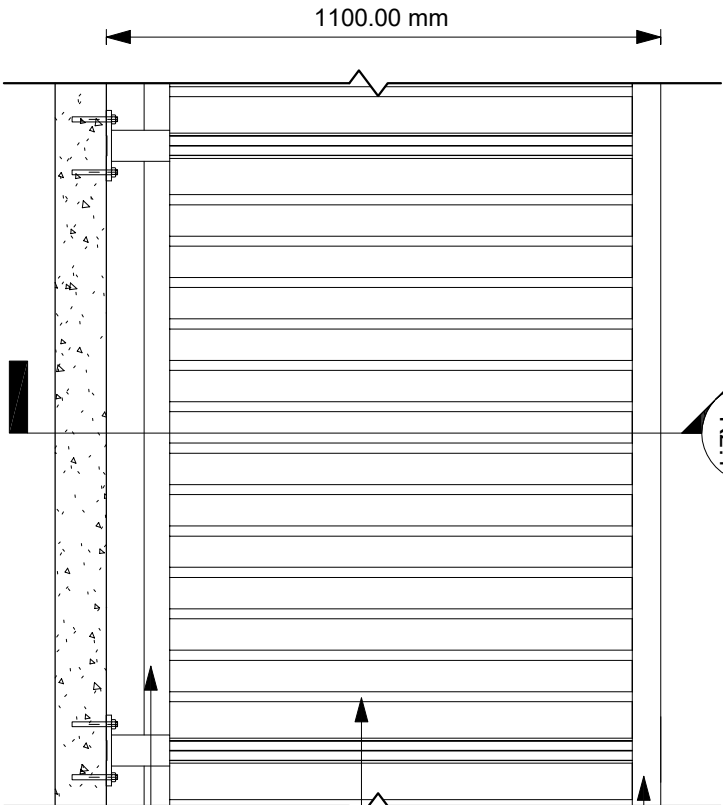
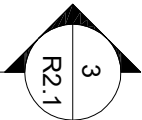

1100.00 mm

2 Front view
1 : 15

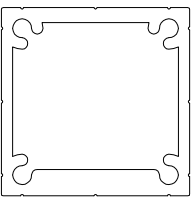

6 LRP001
1 : 2

7 LRT001
1 : 5

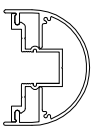

8 LRT002
1 : 5



9 LRT003
1 : 5

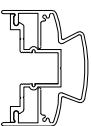

10 LRT004
1 : 5

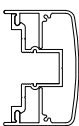

3 Cross section
1 : 15

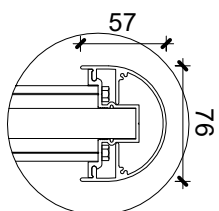
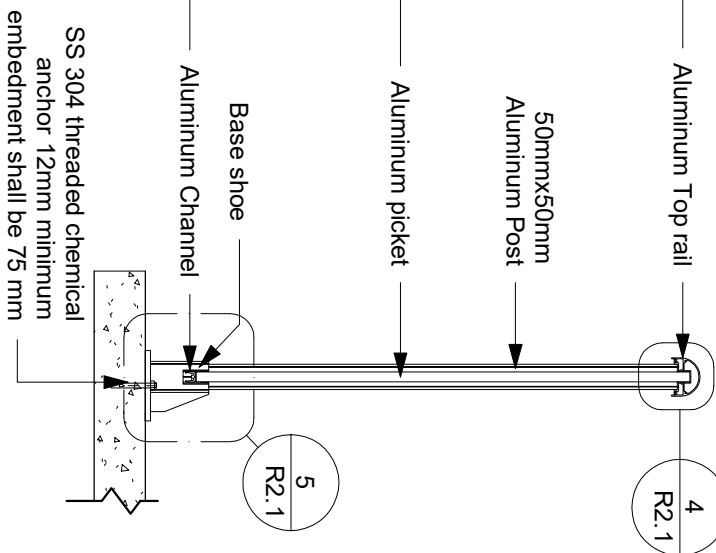

4 Detail 1
1 : 5

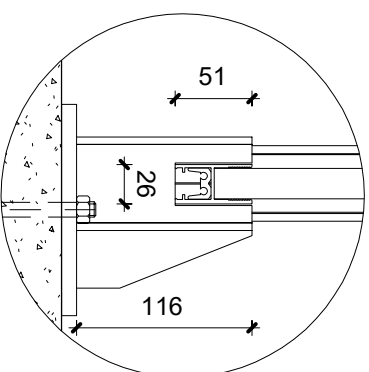

5 Detail 2
1 : 5

General Notes

No.	Revision/Issue	Date

Link
RAILINGS
LINK ALUMINUM RAILING
589 MIDDIEFIELD ROAD,
SCARBOROUGH, ON
linkaluminumrailings@gmail.com

LRAP-0001 Top
Mounted Picket system

Project	Sheet
Date 22-04-2022	R2.1
Scale N.T.S.	